

HSB-600
HSB-6501
HDMI LINK

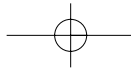



OPERATING INSTRUCTIONS

HSB-600
HSB-6501
HDMI LINK

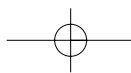
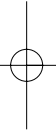
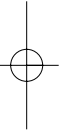

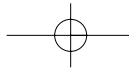



Introduction

READ THIS BEFORE OPERATING YOUR UNIT

| | | |
|--|--|---|
|  | <div style="border: 1px solid black; padding: 2px; width: fit-content; margin: 0 auto;"> <p>CAUTION RISK OF ELECTRIC SHOCK DO NOT OPEN</p> </div> |  |
| <p>CAUTION : TO REDUCE THE RISK OF ELECTRIC SHOCK, DO NOT REMOVE COVER (OR BACK). NO USER-SERVICEABLE PARTS INSIDE. REFER SERVICING TO QUALIFIED SERVICE PERSONNEL.</p> | | |

| | |
|---|---|
|  | <p>This symbol is intended to alert the user to the presence of uninsulated "dangerous voltage" within the product's enclosure that may be of sufficient magnitude to constitute a risk of electric shock to persons.</p> |
|  | <p>This symbol is intended to alert the user to the presence of important operating and maintenance (servicing) instructions in the literature accompanying the appliance.</p> |

WARNING : TO REDUCE THE RISK OF FIRE OR ELECTRIC SHOCK, DO NOT EXPOSE THIS APPLIANCE TO RAIN OR MOISTURE.

FCC INFORMATION(FOR U.S.A.)

This equipment has been tested and found to comply with the limits for a Class B digital device, pursuant to Part 15 of the FCC Rules. These limits are designed to provide reasonable protection against harmful interference in a residential installation. This equipment generates, uses and can radiate radio frequency energy and, if not installed and used in accordance with the instructions, may cause harmful interference to radio communications. However, there is no guarantee that interference will not occur in a particular installation. If this equipment does cause harmful interference to radio or television reception, which can be determined by turning the equipment off and on, the user is encouraged to try to correct the interference by one or more of the following measures:

- Reorient or relocate the receiving antenna.
- Increase the separation between the equipment and receiver.
- Connect the equipment into an outlet on a circuit different from that to which the receiver is connected.
- Consult the dealer or an experienced radio/TV technician for help.

CAUTION : Any changes or modifications in construction of this device which are not expressly approved by the party responsible for compliance could void the user's authority to operate the equipment.

NOTE ON RECYCLING (FOR EUROPE)

This product's packaging materials are recyclable and can be reused. Please dispose of any materials in accordance with the local recycling regulations.

When discarding the unit, comply with local rules or regulations.

Batteries should never be thrown away or incinerated but disposed of in accordance with the local regulations concerning chemical waste.

This product and the accessories packed together constitute the applicable product according to the WEEE directive except batteries.

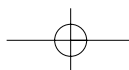

SAFETY INSTRUCTIONS

1. **Read Instructions** - All the safety and operating instructions should be read before the product is operated.
2. **Retain instructions** - The safety and operating instructions should be retained for future reference.
3. **Heed Warnings** - All warnings on the product and in the operating instructions should be adhered to.
4. **Follow Instructions** - All operating and use instructions should be followed.
5. **Cleaning** - Unplug this product from the wall outlet before cleaning. Do not use liquid cleaners or aerosol cleaners. Use a damp cloth for cleaning.
6. **Attachments** - Do not use attachments not recommended by the product manufacturer as they may cause hazards.
7. **Water and Moisture** - Do not use this product near water - for example, near a bath tub, wash bowl, kitchen sink, or laundry tub; in a wet basement, or near a swimming pool; and the like.
8. **Accessories** - Do not place this product on an unstable cart, stand, tripod, bracket, or table. The product may fall, causing serious injury to a child or adult, and serious damage to the product. Use only with a cart, stand, tripod, bracket, or table recommended by the manufacturer, or sold with the product. Any mounting of the product should follow the manufacturer's instructions, and should use a mounting accessory recommended by the manufacturer.
9. A product and cart combination should be moved with care. Quick stops, excessive force, and uneven surfaces may cause the product and cart combination to overturn.
10. **Ventilation** - Slots and openings in the cabinet are provided for ventilation and to ensure reliable operation of the product and to protect it from overheating, and these openings must not be blocked or covered. The openings should never be blocked by placing the product on a bed, sofa, rug, or other similar surface. This product should not be placed in a built-in installation such as a bookcase or rack unless proper ventilation is provided or the manufacturer's instructions have been adhered to.
11. **Power Sources** - This product should be operated only from the type of power source indicated on the marking label. If you are not sure of the type of power supply to your home, consult your product dealer or local power company. For products intended to operate from battery power, or other sources, refer to the operating instructions.
12. **Grounding or Polarization** - This product may be equipped with a polarized alternating-current line plug (a plug having one blade wider than the other). This plug will fit into the power outlet only one way. This is a safety feature. If you are unable to insert the plug fully into the outlet, try reversing the plug. If the plug should still fail to fit, contact your electrician to replace your obsolete outlet. Do not defeat the safety purpose of the polarized plug.
Alternate Warnings - This product is equipped with a three-wire grounding-type plug, a plug having a third (grounding) pin. This plug will only fit into a grounding-type power outlet. This is a safety feature. If you are unable to insert the plug into the outlet, contact your electrician to replace your obsolete outlet. Do not defeat the safety purpose of the grounding-type plug.
13. **Power-Cord Protection** - Power-supply cords should be routed so that they are not likely to be walked on or pinched by items placed upon or against them, paying particular attention to cords at plugs, convenience receptacles, and the point where they exit from the product.
14. **Outdoor Antenna Grounding** - If an outside antenna or cable system is connected to the product, be sure the antenna or cable system is grounded so as to provide some protection against voltage surges and built-up static charges. Article 810 of the National Electrical Code, ANSI/NFPA 70, provides information with regard to proper grounding of the mast and supporting structure, grounding of the lead-in wire to an antenna discharge unit, size of grounding conductors, location of antenna-discharge unit,



PORTABLE CART WARNING

connection to grounding electrodes, and requirements for the grounding electrode. See Figure 1.

Figure 1
Example of antenna grounding as per National Electrical Code, ANSI/NFPA 70

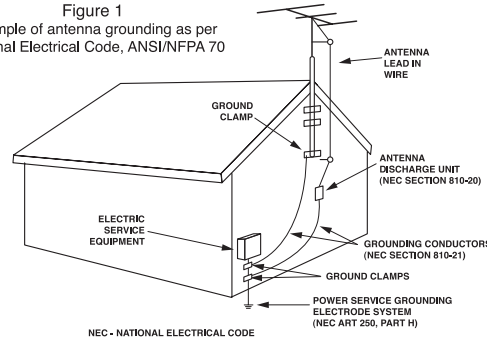

15. **Lightning** - For added protection for this product during a lightning storm, or when it is left unattended and unused for long periods of time, unplug it from the wall outlet and disconnect the antenna or cable system. This will prevent damage to the product due to lightning and power-line surges.
16. **Power Lines** - An outside antenna system should not be located in the vicinity of overhead power lines or other electric light or power circuits, or where it can fall into such power lines or circuits. When installing an outside antenna system, extreme care should be taken to keep from touching such power lines or circuits as contact with them might be fatal.
17. **Overloading** - Do not overload wall outlets, extension cords, or integral convenience receptacles as this can result in a risk of fire or electric shock.
18. **Object and Liquid Entry** - Never push objects of any kind into this product through openings as they may touch dangerous voltage points or short-out parts that could result in a fire or electric shock. Never spill liquid of any kind on the product.
19. **Servicing** - Do not attempt to service this product yourself as opening or removing covers may expose you to dangerous voltage or other hazards. Refer all servicing to qualified service personnel.
20. **Damage Requiring Service** - Unplug this product from the wall outlet and refer servicing to qualified service personnel under the following conditions:
 - a) When the power-supply cord or plug is damaged,
 - b) If liquid has been spilled, or objects have fallen into the product,
 - c) If the product has been exposed to rain or water,
 - d) If the product does not operate normally by following the operating instructions. Adjust only those controls that are covered by the operating instructions as an improper adjustment of other controls may result in damage and will often require extensive work by a qualified technician to restore the product to its normal operation.
 - e) If the product has been dropped or damaged in any way, and
 - f) When the product exhibits a distinct change in performance - this indicates a need for service.
21. **Replacement Parts** - When replacement parts are required, be sure the service technician has used replacement parts specified by the manufacturer or have the same characteristics as the original part. Unauthorized substitutions may result in fire, electric shock, or other hazards.
22. **Safety Check** - Upon completion of any service or repairs to this product, ask the service technician to perform safety checks to determine that the product is in proper operating condition.
23. **Wall or Ceiling Mounting** - The product should be mounted to a wall or ceiling only as recommended by the manufacturer.
24. **Heat** - The product should be situated away from heat sources such as radiators, heat registers, stoves, or other products (including amplifiers) that produce heat.

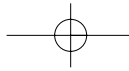

| FOR YOUR SAFETY | | |
|---|------------------------------|---|
| U.S.A and CANADA | 120 V | Units shipped to the U.S.A and Canada are designed for operation on 120 V AC only. Safety precaution with use of a polarized AC plug. However, some products may be supplied with a nonpolarized plug. CAUTION : To prevent electric shock, match wide blade of plug to wide slot, fully insert. ATTENTION : Pour éviter chocs électriques, introduire la lame la plus large de la fiche dans la borne correspondante de la prise et pousser jusqu' au fond. |
| CHINA, EUROPE, AUSTRALIA and other countries | 220 V - 240 V | The available power supply voltage differs according to country or region. However, this unit is equipped with an Automatic Voltage Selector. The power supply voltage of the area where the unit will be used automatically meets the required voltage within the range of AC 220 - 240 V, without any manual voltage adjustment. To ensure safe operation, the three-pin plug supplied must be inserted only into a standard three-pin power point which is effectively earthed through the normal household wiring. Extension cords used with the equipment must be three-core and be correctly wired to provide connection to earth. Improper extension cords are a major cause of fatalities. The fact that the equipment operates satisfactorily does not imply that the power point is earthed and that the installation is completely safe. For your safety, if in any doubt about the effective earthing of the power point, consult a qualified electrician. |

| CAUTION |
|--|
| <ul style="list-style-type: none"> • Leave a space around the unit for sufficient ventilation. • Avoid installation in extremely hot or cold locations, or in an area that is exposed to direct sunlight or heating equipment. • Keep the unit free from moisture, water, and dust. • Do not let foreign objects in the unit. • The ventilation should not be impeded by covering the ventilation openings with items, such as newspapers, table-cloths, curtains, etc. • No naked flame sources, such as lighted candles, should be placed on the unit. • Please be care the environmental aspects of battery disposal. • The unit shall not be exposed to dripping or splashing for use. • No objects filled with liquids, such as vases, shall be placed on the unit. • Do not let insecticides, benzene, and thinner come in contact with the set. • Never disassemble or modify the unit in any way. <p style="margin-left: 20px;">Notes on the AC power cord and the wall outlet</p> <ul style="list-style-type: none"> • The unit is not disconnected from the AC power source(mains) as long as it is connected to the wall outlet, even if the unit has been turned off. • When disconnecting the power cord from the wall outlet, always pull the plug, not the power cord. • Disconnect the plug from the wall outlet when not using the unit for long periods of time. • The wall outlet shall be installed near the unit and shall be easily accessible. |

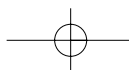

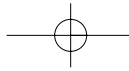

CONTENTS

Introduction

- READ THIS BEFORE OPERATING YOUR UNIT | 2
- SAFETY INSTRUCTIONS | 3
- ACCESSORIES | 5

Part Names and Functions

- FRONT PANEL | 6
- BACK PANEL | 6
- REMOTE CONTROL | 6
- REMOTE CONTROL OPERATION RANGE | 7
- LOADING BATTERY | 7

System Connections

- CONNECTING TV AND THE SOURCE EQUIPMENT WITH COMPONENT VIDEO OUTs | 8
- CONNECTING TV AND THE SOURCE EQUIPMENT WITH HDMI OUTs | 10
- CONNECTING MULTI-ROOM SYSTEM KIT | 11

Operations | 12

Definition of Terms | 13

Troubleshooting Guide | 14

Specifications | 15

ACCESSORIES

- | | |
|---------------------------|--|
| 1. Operating Instructions | 3. Remote Control |
| 2. HDMI Cable | 4. Battery (CR2025, 3V, Lithium battery) |

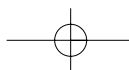
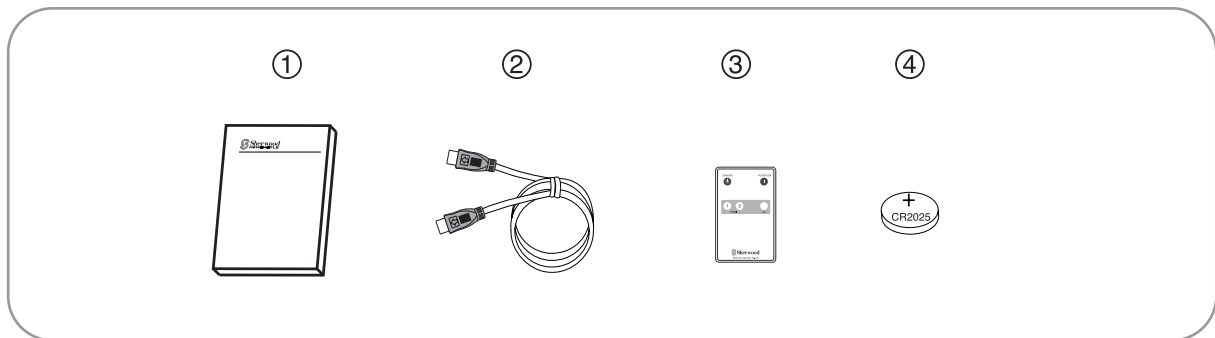

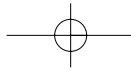

Part Names and Functions

FRONT PANEL

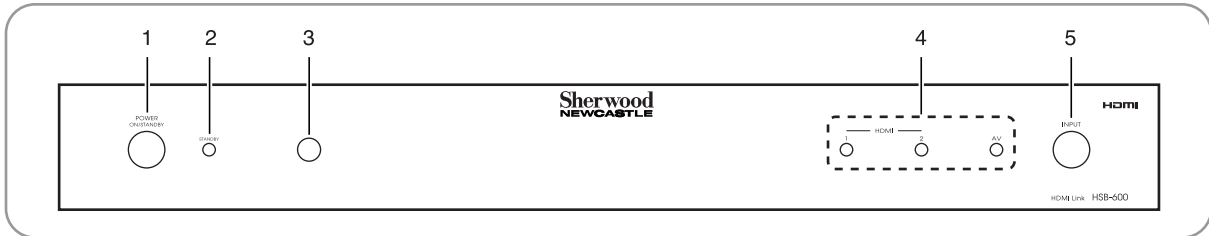

1. POWER (ON/STANDBY) button

Each time the POWER button is pressed, this unit is turned on to enter the operating mode or off to enter the standby mode.

2. STANDBY Indicator

In the standby mode, the STANDBY indicator lights up.

3. Remote sensor

This receives the signals from the remote control unit.

4. HDMI 1, 2 and AV Indicators

Each time the INPUT selector button is pressed, the corresponding indicator lights up.

5. INPUT selector button

Press this button to select the desired input source.

BACK PANEL

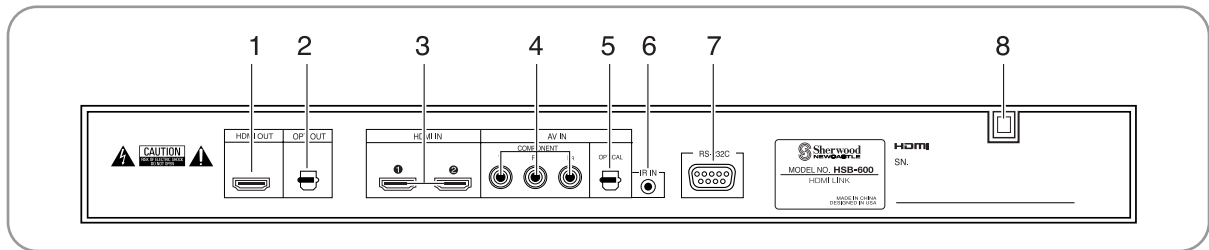

1. HDMI OUT

2. OPTICAL OUT (Digital Audio)

3. HDMI INs 1 and 2

4. COMPONENT INs (Analog Video)

5. OPTICAL IN (Digital Audio)

6. IR IN

7. RS-232C

8. AC INPUT cord

REMOTE CONTROL

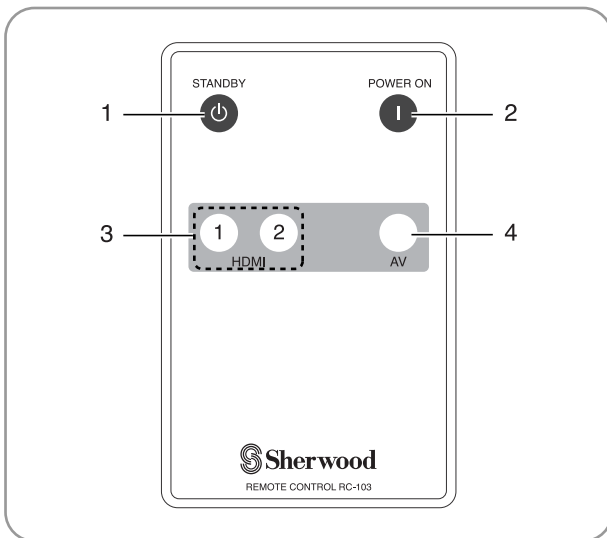

1. STANDBY button

Press the STANDBY button to enter the standby mode.

2. POWER ON button

Press the POWER ON button to enter the operating mode.

3. HDMI 1, 2 input selector button

Press the HDMI 1 or 2 button to select the desired input.

4. AV input selector button

Press the AV button to select the desired input.

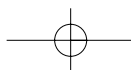

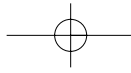

REMOTE CONTROL OPERATION RANGE

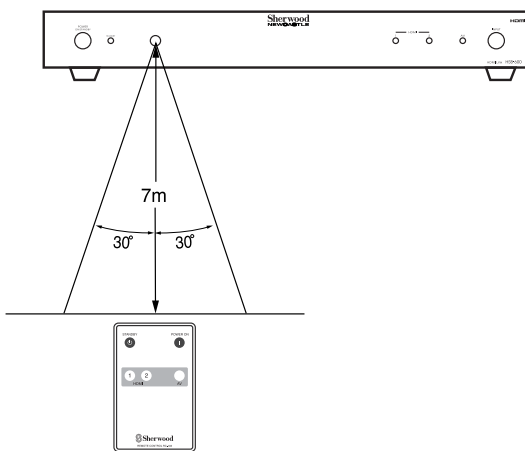

• Use the remote control unit within a range of about 7 meters (23 feet) and angles of up to 30 degrees aiming at the remote sensor.

LOADING BATTERY

1 Remove the cover.

2 Load the battery(CR2025) matching the polarity.

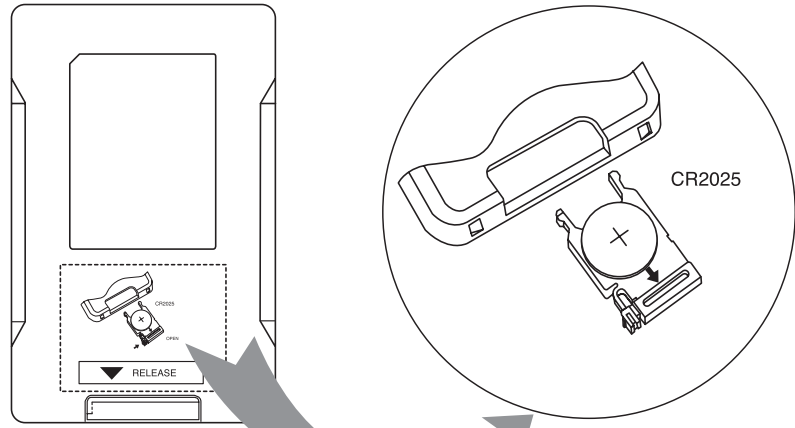

1. PUSH

2. PULL

CR2025

• Remove the battery when it is not used for a long time.

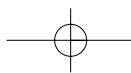

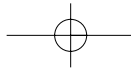

System Connections

- Do not plug the AC input cord into the wall AC outlet until all connections are completed.
- Be sure to observe the color coding when connecting component cords.
- Make connections firmly and correctly. If not, it can cause loss of sound, noise or damage to this unit.
- The supplied cord is a HDMI cord only. Other cords are commercially available cords.

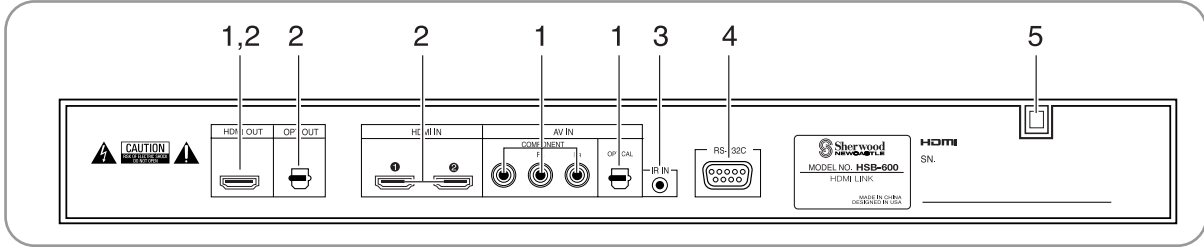

1. CONNECTING TV AND THE SOURCE EQUIPMENT WITH COMPONENT VIDEO OUTS

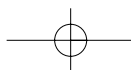
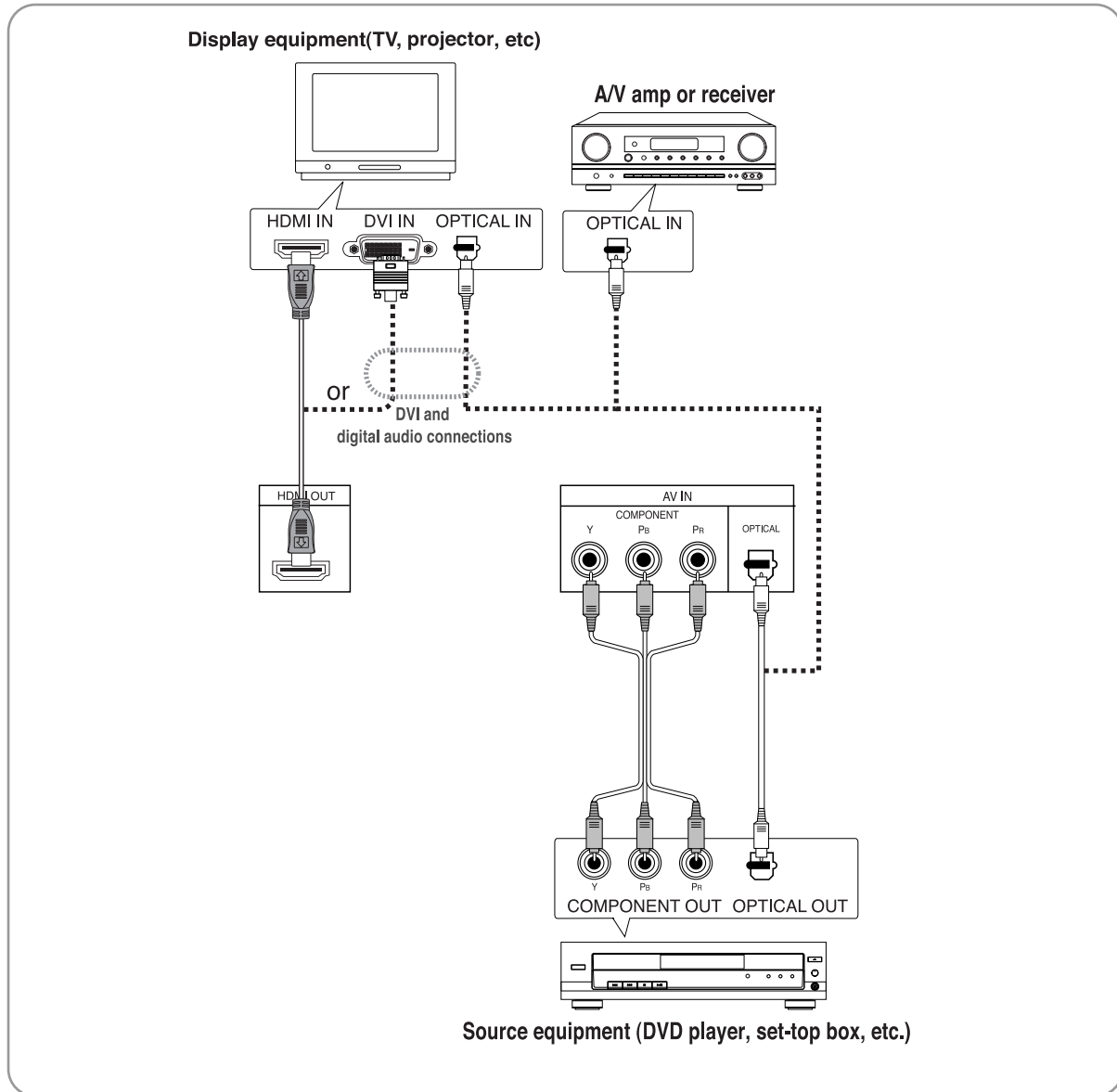

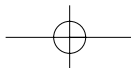

Connecting the source equipment with the COMPONENT VIDEO OUTs

- When you connect the COMPONENT VIDEO OUTs of the source equipment to this unit, this unit can convert the component video signals to the digital video signals and output them from the HDMI OUT connector of this unit.
- In addition, when you connect the OPTICAL OUT to this unit, this unit can output the digital signals as they were input from the HDMI OUT connector, too.
- When making the component video connections, connect "Y" to "Y", Pb to "PB"(or "B-Y", "CB") and "Pr" to "PR"(or "R-Y", "CR").

Connecting the display equipment with the HDMI IN connector

- The HDMI connection can carry uncompressed digital video signals and digital audio signals.
- If your display equipment (TV, projector, etc.) has the HDMI IN connector, connect it to the HDMI OUT connector of this unit using the supplied HDMI cord.
- Among the HDMI IN connector equipped TV or projector, etc., some do not support audio output(for examples, projectors).

In such a case, make the digital audio connection(and the analog audio connection if needed) between the source equipment and the display equipment(or A/V amp, receiver).

Connecting the display equipment with the DVI IN connector

- If your display equipment has the DVI IN connector compatible with DVI and High-bandwidth Digital Content Protection (HDCP), connect it to the HDMI OUT connector of this unit using a commercially available HDMI-DVI converter cord.

Since the HDMI-to-DVI connection cannot carry audio signals, you should make the digital audio connection(and the analog audio connection if needed) between the source equipment and the display equipment (or A/V amp, receiver).

Notes :

- This unit supports HDMI(High Definition Multimedia Interface) version 1.1
- This unit supports HDCP(High-bandwidth Digital Content Protection), a protection system for digital video. If not, the image will not be output properly.
- This unit supports 480p(576p), 720p, 1080i as the resolution of video signals. Therefore, when making COMPONENT VIDEO connections, be sure to output the progressive video signals (480p or 576p) from your source equipment. If your source equipment outputs the interlaced video signals (480i or 576i), the HDMI OUT of this unit will output no video signals or abnormal video signals.
- Depending on the equipment, using a DVI connection may result in unreliable signal transfers.
- Depending on the display equipment, you may specify the resolution and the audio format on the source equipment to match them the display equipment supports. (For details on the resolution and the audio format, refer to the operating instructions of your equipments.)

HDMI and DVI connectors

- When connecting the source equipment to the display equipment through this unit, this table shows the compatibility of connections between the HDMI/DVI IN and the HDMI/DVI OUT connectors.

| DVD player, set-top box, etc. / TV, projector, etc. | HDMI IN connector | DVI IN connector (HDCP compatible) | DVI IN connector (HDCP incompatible) |
|---|---------------------|------------------------------------|--------------------------------------|
| HDMI OUT connector | (Video/Audio) | (Only Video) | - |
| DVI OUT connector (HDCP compatible) | (Only Video) | (Only Video) | - |
| DVI OUT connector (HDCP incompatible) | (*) (Only Video) | (*) (Only Video) | (*) (Only Video) |

(*): Transferring the video signals via the DVI connector may be limited by the source equipment and the display equipment that are connected. (For details, refer to the operating instructions of your equipments.)

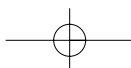

2. CONNECTING TV AND THE SOURCE EQUIPMENT WITH HDMI OUTs

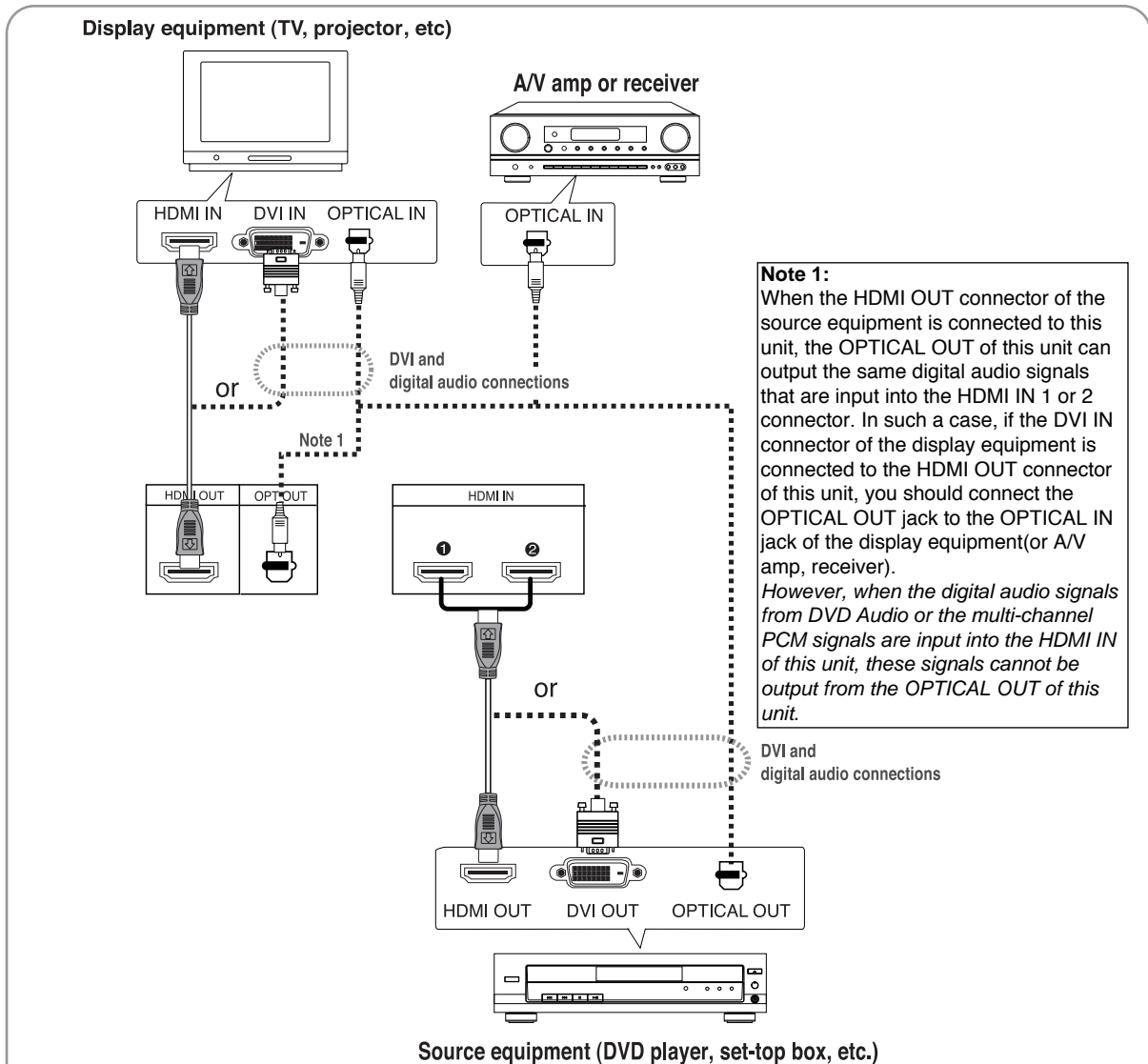

- The HDMI connection can carry uncompressed digital video signals and digital audio signals.
- This unit can output digital video and digital audio signals from the HDMI OUT of this unit without any conversion as they were input into the HDMI IN.

Connecting the source equipment with the HDMI OUT connector

- If your source equipment (DVD player, set-top box, etc.) has the HDMI OUT connector, connect it to the HDMI IN 1 or 2 connector of this unit using a commercially available HDMI cord.

Connecting the source equipment with the DVI OUT connector

- If your source equipment has the DVI OUT connector compatible with DVI and High-bandwidth Digital Content Protection (HDCP), connect it to the HDMI IN 1 or 2 connector of this unit using a commercially available HDMI-DVI converter cord.

Since the HDMI-to-DVI connection cannot carry audio signals, you should make the digital audio connection (and the analog audio connection if needed) between the source equipment and the display equipment (or A/V amp, receiver)

Connecting the display equipment

- For details on how to connect the display equipment, refer to "Connecting the display equipment with the HDMI IN connector" and "Connecting the display equipment with the DVI IN connector" on previous page.

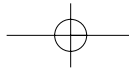

3. CONNECTING MULTI-ROOM SYSTEM KIT

- The multi-room system kit(sold separately) is essential for operation from a remote location.
For information on the multi-room system kit, contact the Xantech corporation at 1-800-843-5465 or www.xantech.com.
- IR IN jack allows you to control this receiver from another room with the remote control unit.
- To control this unit from another room with the remote control unit, connect the IR IN jack to the output of the connecting block.
- If this unit is located inside a cabinet or other enclosure where the infrared beams from the remote control unit cannot enter, then operation with the remote control unit will not be possible.
In such a case, connect the IR IN jack to the output of the connecting block.

Note:

- Remote operation may become unreliable if the IR receiver is exposed to strong light such as direct sunlight or inverted fluorescent.

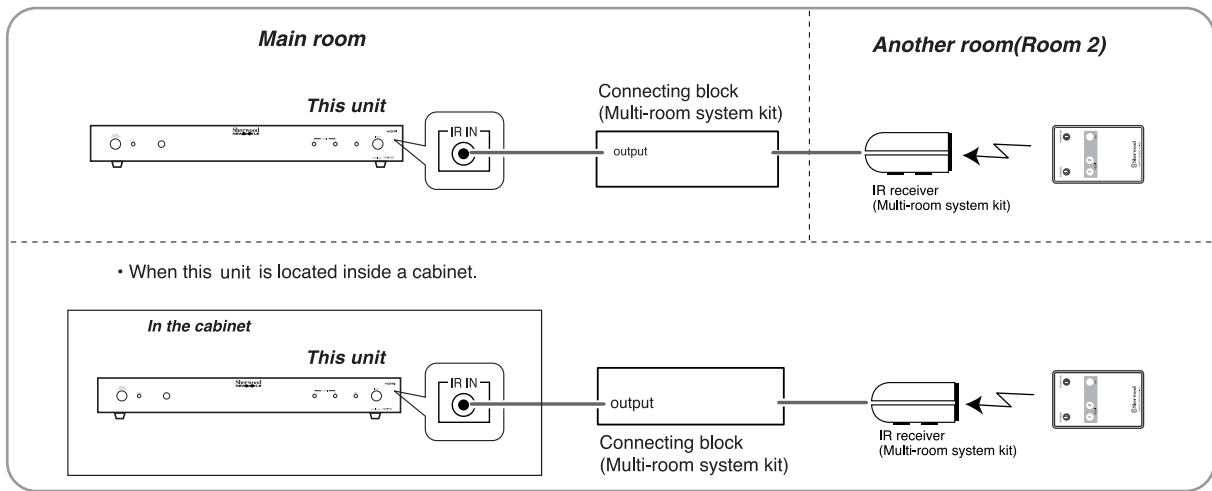

4. RS-232C

- This port may be used to update the operating software, etc. for improvement in the future.

5. AC INPUT CORD

- Plug this cord into a wall AC outlet.

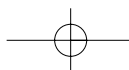

Operations

1

Turn the power on.

POWER ON/STANDBY



or

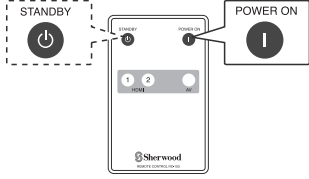

- Each time the POWER(ON/STANDBY) button on the front panel is pressed, this unit is turned on to enter the operating mode (the STANDBY indicator lights up in blue) or off to enter the standby mode (the STANDBY indicator lights up in red).
- On the remote control, press the POWER ON button to enter the operating mode or press the STANDBY button to enter the standby mode.
- In the standby mode, the STANDBY indicator lights up in red. This means that the unit is not disconnected from the AC mains and a small amount of current is retained to support the operation readiness.

2

Select the desired input source.

INPUT



or

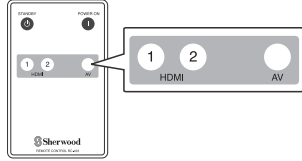

- Each time the "INPUT" button on the front panel is pressed, the input source changes as follows;

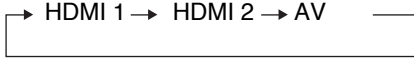

- Each time the input source is changed, the corresponding indicator lights up.

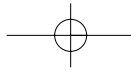

Definition of Terms

HDMI

HDMI(High Definition Multimedia Interface) is a new connection format that supports both video and audio on a single digital connection.

The HDMI connection carries uncompressed, standard or high definition digital video signals and multi-channel audio signals to AV components such as HDMI equipped TVs, in digital form without degradation.

Since the video signals from HDMI jack are compatible with the current DVI(Digital Visual Interface) format, HDMI jacks can be connected to DVI jacks by way of an HDMI-DVI converter cord. The HDMI specification supports HDCP(High-bandwidth Digital Contents Protection), a copy protection technology that incorporates coding technology for digital video signals.

HDMI, the HDMI logo and High-Definition Multimedia Interface are trademarks or registered trademarks of HDMI licensing LLC.

HDCP

HDCP(High-bandwidth Digital Content Protection) is a specified method from Intel for protecting copyrighted digital entertainment content that uses the Digital Video Interface (DVI) by encrypting its transmission between the video source and the digital display (receiver). The video source might be a computer, set-top box, or digital versatile disc (DVD) player, and the digital display might be an liquid crystal display (LCD), television, plasma panel, or projector.

DVI

DVI(Digital Video Interface) is a specification created by the Digital Display Working Group(DDWG) to accommodate analog and digital monitors with a single connector. There are three different DVI configurations : DVI-A, designed for analog signals, DVI-D, designed for digital signals, and DVI-I(integrated), designed for both analog and digital signals.

Using a DVI connector and port, a digital signal that is sent to an analog monitor is converted into an analog signal. If the monitor is a digital monitor, such as a flat panel display, no conversion is necessary. Many monitors now include a DVI connection and many video adapters include a DVI port along with, or instead of, the traditional 15-pin Video Graphics Array (VGA) port.

Component Video

Video signals with three channels of separate information that makes up the picture. There are some types of component video, such as Y/CB(PB)/CR(PR) and R/G/B.

Dolby Digital

Dolby Digital provides multichannel surround sound in cinemas from 35mm film and in the home from laser discs, DVDs, and digital broadcast television, cable, and satellite systems. It enables the transmission and storage of up to five full-range audio channels, plus a low-frequency effects channel(LFE), thus 5.1 channels, in less space than is required for just one linear PCM-coded channel on a compact disc.

Manufactured under license from Dolby Laboratories. "Dolby" and the double-D symbol are trademarks of Dolby Laboratories.

DTS

DTS(Digital Theater Systems) is a newly-developed surround system which can handle more amount of data, providing better audio quality. Though the number of audio channels is 5.1 which is same as Dolby Digital, discs bearing the "DTS" provides fat sound and better signal-to-noise ratio, thanks to the lower audio compression ratio format. It also provides wide dynamic range and better separation, resulting in magnificent sound.

"DTS" and "DTS Digital Surround" are registered trademarks of Digital Theater Systems, Inc.

Bitstream

The digital signal form of multichannel audio data (e.g., 5.1 channel) before it is decoded into its various channels.

Linear PCM

PCM stands for Pulse Code Modulation. Linear PCM is the usual digital method without compression, used for audio playback of audio CDs, DVD Videos, etc.

Packed PCM

A lossless compression system that enables more PCM audio to be stored on a DVD-Audio disc than would otherwise be possible.

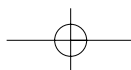

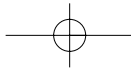

Troubleshooting Guide

If a fault occurs, run through the table below before taking your unit for repair.

If the fault persists, attempt to solve it by switching the unit off and on again. If this fails to resolve the situation, consult your dealer. Under no circumstances should you attempt to repair the unit yourself. This could void the warranty.

HDMI troubleshooting

- This unit has been designed to be compliant with HDMI(High Definition Multimedia Interface) version 1.1. Depending on the component you have connected, unreliable signal transfers may result. In addition, some functions may be limited.
(For details, refer to the operating instructions of the connected TV, DVD player, etc.)

| PROBLEM | POSSIBLE CAUSE | REMEDY |
|--|---|---|
| No power | <ul style="list-style-type: none"> The AC input cord is disconnected. Poor connection at AC wall outlet or the outlet is dead or off. | <ul style="list-style-type: none"> Connect cord securely. Check the outlet using a lamp or another appliance. |
| No picture and sound | <ul style="list-style-type: none"> The HDMI cord(or HDMI to DVI converter cord) are disconnected. The incorrect selection of input source on the TV. The DVD player is playing a DVD-Audio with CPPM. | <ul style="list-style-type: none"> Connect the cord correctly. Select the input source correctly. The HDMI OUT connector does not output the video and audio signals of it. |
| No picture or abnormal picture | <ul style="list-style-type: none"> This unit is connected to TV, DVD player, etc. that does not support HDCP(High-bandwidth Digital Content Protection). The settings for HDMI, COMPONENT VIDEO, etc. on the DVD player, etc. do not match those of the connected TV. Input selection on this unit is wrong. Component video connections are not made according to color coding. The COMPONENT VIDEO OUTs of the source equipment outputs the interlaced video signals (480i or 576i). | <ul style="list-style-type: none"> This unit will not transfer the video signals. This is not malfunction. Use the TV and DVD player, etc that do support HDCP. Set them correctly depending on the connected TV. Select the input corresponding to signals to be transferred to TV. Connect Y to Y, Pb to Pb(or B-Y, Cb) and Pr to Pr(or R-Y, Cr). Output the progressive video signals (480p or 576p). |
| No sound or abnormal sound | <ul style="list-style-type: none"> The HDMI OUT connector of this unit is connected to the DVI IN connector of TV,etc. | <ul style="list-style-type: none"> The DVI connector does not accept audio signals. In such a case, you should make optical digital connection between the components. |
| Do not operate with remote control unit. | <ul style="list-style-type: none"> Battery dead. Remote control unit is too far from this unit. The remote sensor is obstructed. and ends of battery inserted in reverse. | <ul style="list-style-type: none"> Replace with new battery. Move closer. Remove obstacle. Insert battery properly. |

Reference to connection

- This figure shows the best way of connections among the source equipments, this unit and the display equipment.

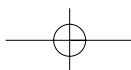
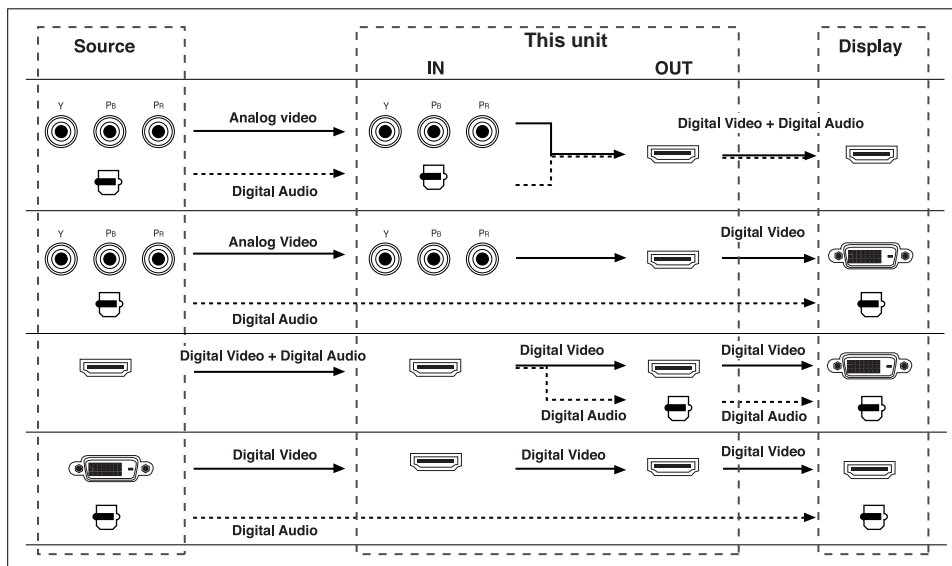

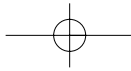

Specifications

- Digital input/output level
 - Optical, 660 nm | **-21 ~ -15 dBm**
- Component video input sensitivity, 75 Ω (75% color bar)
 - R-Y signal | **0.5 Vp-p**
 - B-Y signal | **0.5 Vp-p**
 - Y signal | **1.0 Vp-p**
- HDMI | **19 pin**
 - Picture resolution | **480p(576p), 720p, 1080i**
 - Audio sampling frequency | **32, 44.1, 48, 96, 192kHz**
- Power supply
 - U.S.A. and Canada | **120 V ~ 60 Hz**
 - China, Europe, Australia and other countries | **220- 240 V ~ 50/60 Hz**
- Power consumption | **3 W**
- Dimensions (W x H x D, including protruding parts) | **440 x 55 x 233mm(17-5/16 x 2-3/16 x 9-3/16 inches)**
- Weight (net) | **2.3 kg (5.07lbs)**

Note: Design and specifications are subject to change without notice for improvements.

